



*An Online CPD Course
brought to you by
CEDengineering.ca*

Air Conditioning with Thermal Energy Storage

Course No: M04-028
Credit: 4 PDH

A. Bhatia

CED CANADA
engineering.ca
CPD FOR THE PROFESSIONAL

Continuing Education and Development, Inc.

P: (877) 322-5800
info@cedengineering.ca

www.cedengineering.ca

Air-Conditioning with Thermal Energy Storage

Abstract

Thermal Energy Storage (TES) for space cooling, also known as cool storage, chill storage, or cool thermal storage, is a cost saving technique for allowing energy-intensive, electrically driven cooling equipment to be predominantly operated during off-peak hours when electricity rates are lower. TES may be considered as a useful tool to reduce the number of refrigeration machines by means of spreading the daytime load over 24 hours period. Hence, any type of TES systems can be considered as useful tool to reduce the overall environmental impact for a given cooling application.

There are many different types of cool storage systems representing different combinations of storage media, charging mechanisms, and discharging mechanisms. The basic media options are chilled water, ice, and eutectic salts. Chilled water uses rely solely on the sensible (i.e., no phase change or latent energy) heat capacity of water and the temperature difference between supply and return water streams going to and from the cooling load. Ice systems and eutectic salts use only latent heat associated w/ freezing and melting. The difference lies in the heat absorbing capacity.

This 4-hr course provides the overview of Thermal Storage Systems and is divided into 5 sections:

- PART – I Overview of Thermal Energy Storage Systems
- PART – II Chilled Water Storage Systems
- PART – III Ice Thermal Storage Systems
- PART – IV Selecting a Right System
- PART – V District Cooling System

PART – I OVERVIEW OF THERMAL ENERGY STORAGE SYSTEMS

Thermal energy storage (TES) is a method by which cooling is produced and stored at one time period for use during a different time period. Air conditioning of buildings during summer daytime hours is the single largest contributor to electrical peak demand. Realistically, no building air conditioning system operates at 100% capacity for the entire daily cooling cycle. Air conditioning loads peak in the afternoon -- generally from 2 to 4 PM -- when ambient temperatures are highest, which put an increased demand for cooling and electricity.

Electricity is a commodity that can not be stored economically while it is transmitted through grid and is consumed as it is produced. The electricity generation (MW) depends on the downstream consumption, which is generally at peak (maximum) during afternoon and evening hours and low (lean) at nights and morning hours. While the utilities are committed to deliver the peak demand by increasing their generation capacity, during lean periods when the demand is low, the power plants are forced to operate at low load factor. The low load factor implies that the generating plant will produce below its capacity implying hit on their return on investment and bottom line profits.

Utility companies attempt to minimize the impact of excess and idle capacity through Demand Supply Management (DSM) – a tool to improve the plant load factor through incentive programs and keeping tariff rate structures that penalize customers' poor load factors or exceeding demand limits. Most commercial customers are charged not only for the amount of energy they use, but also for the peak amount of energy they demand. In some places, the local utility provides really attractive rates to customers during night to encourage the electricity use during lean periods.

Building services must be designed to provide sufficient flexibility for load shifting and energy usage control in order to achieve the most economical operation. A Thermal Energy Storage technique whereby "Storing Low Temperature energy for later use in order to bridge the time gap between energy availability and energy use " can be considered as a useful tool to achieve this aim.

Here's how TES Works

The concept behind TES is simple. Water is cooled by chillers during off-peak* hours and stored in an insulated tank. This stored coolness is then used for space conditioning during hot afternoon hours, using only circulating pumps and fan energy in the process.

Electrical costs peak during the day when demand is at its highest and is significantly less during evening hours when demand decreases. TES is considered to be one of the most preferred demand side management technologies for shifting cooling electrical demand from peak daytime hours to off peak night hours.

Terms

DSM- Demand Supply Management is an effort by utility companies to ensure energy optimization by ensuring the power generating plant operates at most efficiently at high load factor all the time.

What is demand charge? : Demand charge is a tariff added to a customer electric bill that increases in proportion to maximum kilowatts used. Many commercial customers pay a monthly demand charge in addition to electric bill based on the largest amount of electricity used during any 30-minute period of the month. TES moves heavy energy usage off-peak, reducing your demand.

Off-Peak: A time period, defined by the utility, when the cost of providing power is relatively low, because the system demand for power is low. The off-peak period is often characterized by lower costs to the customer for energy costs, and either no or low demand charges.

On-Peak: A time period, defined by the utility, when the cost of providing power is high because the system demand for power is high. The on-peak period is typically characterized by higher costs to the customer for energy and/or demand charges.

Advantages of Thermal Energy Systems

Thermal storage systems offer building owners the potential for substantial cost savings by using off-peak electricity to produce chilled water or ice.

A thermal energy storage system benefits consumers primarily in three ways:

1. Load Shifting
2. Lower Capital Outlays
3. Efficiency in Operation

1) Load shifting

Load shifting is primarily the main reason to install a TES system.

- Since TES works during off-peak energy you can take advantage of electrical utilities lower time-of-use rate.

- TES benefits in lower operating costs by saving money on electric bills and avoiding 'on-peak' demand charges.
- TES benefits on reduced demand for electricity during the peak demand periods. Many utilities offer cash incentives and rebates for installing or converting to TES.

2. Lower Capital Outlays:

- Capital costs incurred are comparable to conventional air-conditioning system, with cost saved by using a small refrigeration plant. Storage systems let chillers operate at full load all night instead of operating at full or part load during the day. Depending on the system configuration, the chiller may be smaller than would be required for direct cooling, allowing smaller auxiliaries such as cooling-tower fans, condenser water pumps, or condenser fans. TES tanks allow a reduction of chiller capacity requirements. This is true for both new construction and system expansions. Lower equipment requirements translate to reduce maintenance needs.
- A TES system takes up less space and, when designed in conjunction with an air distribution system and installed during a building's construction phase, requires smaller ducts and fan motors. This can reduce spacing between floors and save you money.
- Optional fire protection advantages
TES tanks are full at all times, availing a massive supply of water in case of fire. Engineers can design a tank to fulfill the dual service of cooling and fire protection. This however need permission of local fire authority and should meet the requirements of NFPA.

3. Efficiency in Operation:

- Conventional systems only operate at partial operating conditions most of the time. In contrast, the chiller used in a TES system operates at full-load conditions for a shorter period of time while the system is being charged. The equipment's operating efficiency increases. TES system chillers always either run in its full efficiency or not at all. In other words the chiller operation is not dependent on the varying load profile of the building.
- Additionally, because the stored cooling equipment typically operates at night when outdoor air temperatures are cooler, heat rejection is improved. The condenser always sees low ambient dry and wet bulb temperatures. The net

effect is usually a net decrease in kWh consumption; by anywhere from a few percent to a few tens of percent.

- TES system provides operational flexibility because the reserved storage capacity ensures enough buffers for varying loads of minimum and maximum demand. Chillers can be stopped during normal working hours for maintenance and service while the ice stored during off-peak period supplies cooling.

Benefits to Electric Utility Company

The benefits of thermal storage to the customer (outlined above) are only a reflection of the thermal storage benefits to the power providers and marketers.

It has been seen that the air-conditioning cooling loads drives peak electric power demand. The air-conditioning accounts for almost 40% electricity consumption in US and as more and more building's square feet and air-conditioned facilities are added up it has a definite impact upstream on the power plant load profile. It is to the advantage of power producers to maintain high load factors and maximize yields from a minimum capital investment.

The advantages of TES systems to electrical utility companies are:

- TES is an effective demand supply management technique. TES systems are electric suppliers' best option for increasing load factors on their generating equipment and avoiding the costs of new generating plants.
- TES reduces the peak demand close to the average loads thus improving the building's "Load Factor" ($\text{Average Load} \div \text{Peak Demand}$). A near flat load factor benefits utility company as it frees up generating capacity to serve the other utility customers.
- Electricity generated at night generally has a lower heat rate (fewer Btu/kW produced) and therefore lowers CO₂ emissions and lessens the potential for global warming. TES provides opportunity to produce more kWh from fewer kW of operating capacity.
- Since thermal storage is displacing on-peak demand, less generating capacity must be maintained in reserve. This means the electric suppliers need not have to bring additional, more costly generating equipment on line to handle this increased demand.

- Fewer generating plants required due to reduced system maximum demand for electricity and thus lower electricity cost in the long run.
- Thermal storage represents one of the few legitimate tools for shifting load. TES provides energy efficiency that benefits society and the customer. The benefits realized by the utility companies are substantial and that's the reason the utility companies offer incentive to end-users to go for TES and other energy conservation technologies.

Thermal Energy Storage Technology

The system essentially consists of a storage medium, a tank, a packaged chiller or built-up refrigeration system, and interconnecting piping, pumps, and controls.

TES systems technology can be characterized by storage medium and storage technology.

Storage media: The basic media options are chilled water, ice, and eutectic salts.

- Chilled water uses only sensible heat storage and thus stores only 1 Btu/lb of water for each °F of temp difference between the stored and returned water;
- Ice systems use only latent heat associated w/ freezing and melting, and one lb. of ice at 32°F absorbs 144 Btu to become 32°F water;
- Eutectic salts also use latent heat associated w/ freezing and melting, but one lb. of solid eutectic salt absorbs only 50 Btu to become liquid.

The storage medium determines how large the storage tank will be and the size and configuration of the HVAC system and components.

Storage technologies: These include chilled water tanks, ice systems, and phase-change materials. Overall, ice systems offer the densest storage capacity but the most complex charge and discharge equipment. Water systems offer the lowest storage density, but are the least complex. Eutectic salts fall somewhere in between.

TES is widely employed either as sensible heat storage (typically stratified chilled water or low temperature fluid storage), or as latent heat storage (typically ice storage). The choice of TES technology for a specific application is often affected by factors such as economy-of-scale, existing chiller plant equipment, desired system operating temperatures, available space, and the preferences or experience of the facility's designer or owner.

CHILLED WATER STORAGE

Chilled water storage is most common on very large projects (typically over 500,000 sq ft) where ample space is available. The steel or concrete tank(s) can be located either above- or belowground. In some cases, the stored water can serve to provide some or all the fire protection water storage. The complexities of assuring thermal stratification make chilled water storage more attractive where the storage tank is very large (and deeper than about 20 feet).

Adding chilled water storage is also an option for an existing facility to meet immediate growth needs while postponing new chiller acquisitions.

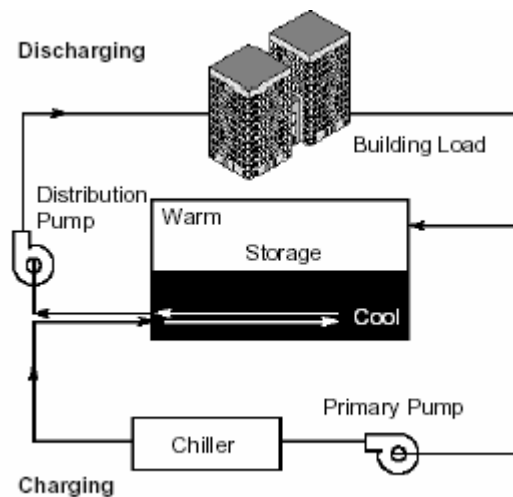

Figure 1: Thermal Energy Storage System with Stratified Chilled Water Storage (Source: ASHRAE)*

These systems use the sensible heat capacity of water (1 Btu per pound per degree Fahrenheit) to store cooling. Sensible heat storage effectiveness depends on the specific heat of the material and, if volume is important, on the density of the storage material.

Sizing Chilled Water Storage Tanks

The British thermal unit (BTU or Btu) is approximately the amount of energy needed to heat 1 pound of water by 1°F or alternatively 1 BTU is the energy stored in 1 pound of water for each 1°F temperature drop.

Assume that chilled water is stored at 40°F and is returned at the standard temp of 55°F, this is a 15°F ΔT for the refrigeration system

Thus, 1 lb of water stores 15 BTU

One ton-hr of refrigeration is 12,000 BTU

So, to store 1 ton-hr you need:

- 800 pounds of water; or
- 96 gallons of water; [note a gallon of water weighs about 8.33 lbs] or
- 12.83 cubic feet of water [note a gallon of water occupies 0.1337 cubic feet]

Tank volume depends on the temperature difference between the water supplied from storage and the water returning from the load, and the degree of separation between warm and cold water in the storage tank. While the most conventional no storage HVAC systems operate on temperature differentials of 10° to 12°F, chilled water storage systems generally need a differential of at least 16°F to keep the storage tank size reasonable. Higher the differential lower shall be the tank volume.

A difference of 20°F is the practical maximum for most building cooling applications, although a few systems exceed 30°F. The practical minimum storage volume for chilled water is approximately 10.7 cubic feet per ton-hour at a 20°F temperature difference.

ICE STORAGE

There are two basic types - Ice Building Systems (static systems) and Ice Harvesting Systems (dynamic systems). Ice storage, being more compact, is most common on smaller commercial buildings or where space for the storage is limited. Ice storage systems, while requiring more refrigeration, can produce lower temperature chilled water, enabling the use of smaller chilled water pumps, piping, and coils. In general, static systems are more compact, simpler, and less costly than dynamic systems. As a result, static or Ice Builder systems seem more popular.

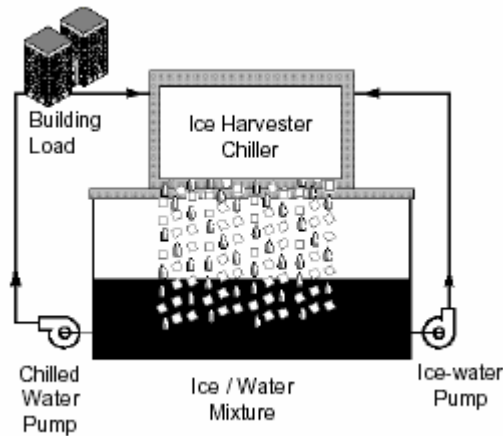

Figure 2: Ice Harvesting
(Source: ASHRAE)*

EUTECTIC SALTS

Eutectic salts, also known as phase change materials, use a combination of inorganic salts, water, and other elements to create a mixture that freezes at a desired temperature. The material is encapsulated in plastic containers that are stacked in a storage tank through which water is circulated. The most commonly used mixture for thermal storage freezes at 47°F, which allows the use of standard chilling equipment to charge storage, but leads to higher discharge temperatures. That in turn limits the operating strategies that may be applied. Eutectic salts thus may be used only in full storage operation and when the dehumidification requirements are low.

Storage Tanks

Storage tanks must have the strength to withstand the pressure of the storage medium, and they must be watertight and corrosion resistant. Aboveground outdoor tanks must be weather resistant. Buried tanks must withstand the weight of their soil covering and any other loads that might occur above the tank, such as the parking of cars. Tanks may also be insulated to minimize thermal losses--typically 1 to 5 percent per day. Options for tank materials include steel, concrete, and plastic.

The storage tank options include either

- 1) Steel tanks
- 2) Concrete tanks
- 3) Plastic tanks

Steel Tanks

Large steel tanks, holding up to several million gallons capacity, are typically cylindrical in shape and field-erected of welded plate steel. Some kind of corrosion protection, such as an epoxy coating, is usually required to protect the tank interior. Small tanks, with capacities of less than 22,000 gallons, are usually rectangular in shape and typically made of galvanized sheet steel. Cylindrical pressurized tanks are generally used to hold between 3,000 and 56,000 gallons.

Concrete Tanks

Concrete tanks may be precast or cast-in-place. Precast tanks are most economical in sizes of one million gallons or more. Cast-in-place tanks can often be integrated with building foundations to reduce costs. However, cast-in-place tanks are more sensitive to thermal shock. Large tanks are usually cylindrical in shape, while smaller tanks may be rectangular or cylindrical.

Plastic Tanks

Plastic tanks are typically delivered as prefabricated modular units. UV stabilizers or an opaque covering are required for plastic tanks used outdoors to protect against the ultraviolet radiation in sunlight.

Steel and concrete are the most commonly used types of tanks for chilled water storage. Most ice harvesting systems and encapsulated ice systems use site-built concrete, while external melt systems usually use concrete or steel tanks, internal melt systems usually use plastic or steel, and concrete tanks with polyurethane liners are common for eutectic salt systems.

PART – II CHILLED WATER STORAGE SYSTEMS

Chilled water (CHW) storage system is not much different from the conventional systems. Since the same fluid (water) is used to store and transfer heat, very few accessories must be added to the system. This gives chilled water storage its principle advantage: It's easy to put in place. Essentially it is just a simple variation of a decoupled chiller system found in many large facilities. Let's study here the common chilled water hydronic schemes below:

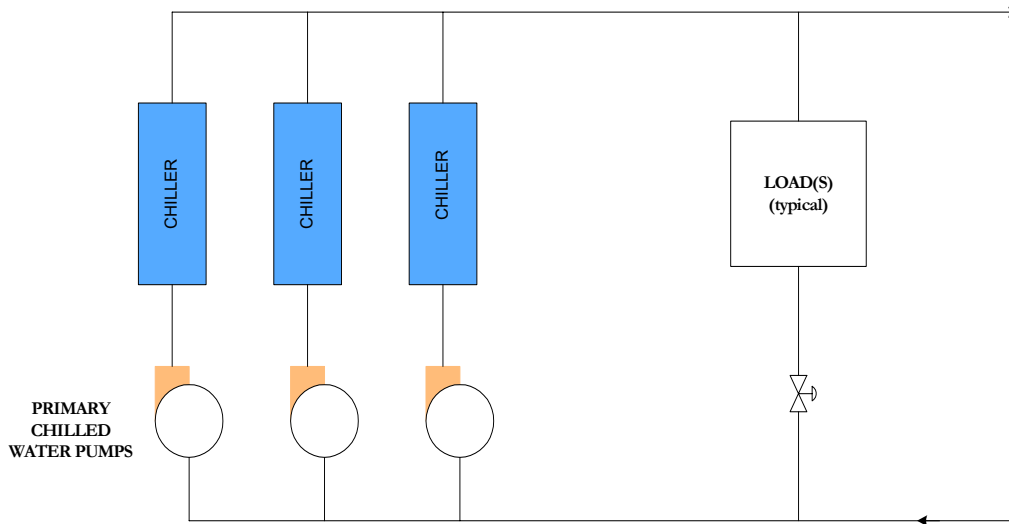

Figure- 1 Chilled Water Hydronic w/constant volume pumping

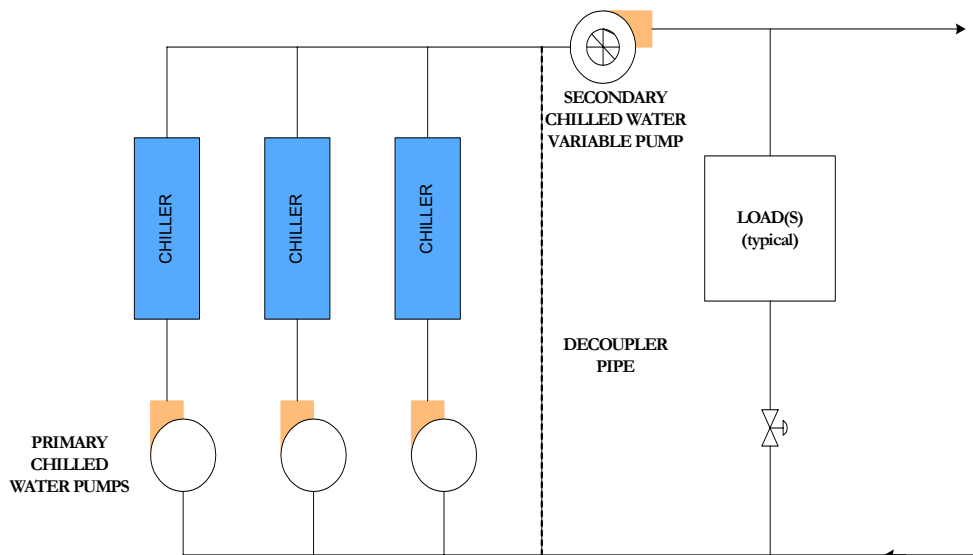

Figure – 2 Chilled Water Hydronic w/primary and secondary pumping

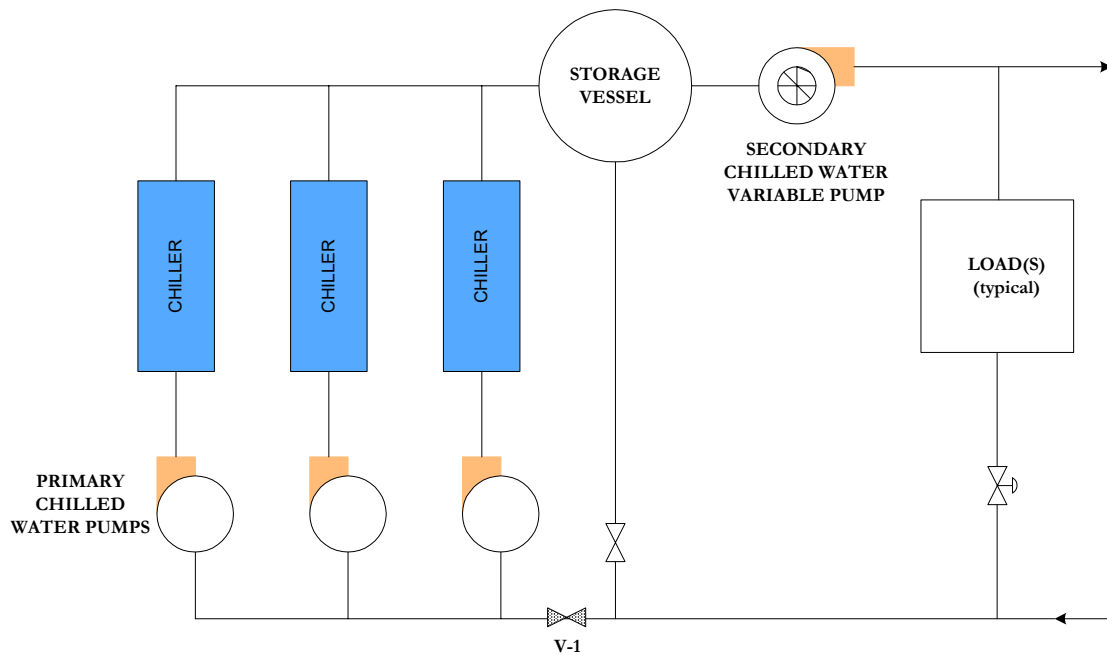

Figure – 3 Chilled Water Hydronic w/ TES

Interpreting the schemes above:

Figure –1: The constant volume chilled water pumps distribute chilled water to various air-handlers/load centers and the return is again cooled and distributed in a closed loop. This is the most common HVAC design provided in most of the commercial buildings.

Figure-2: Here the chilled water system is provided with a decoupled system that separates the production and distribution of chilled water. The primary constant volume pumps are provided with the chiller and the secondary variable volume pumps are provided for distribution to the various air-handling units/load centers. The balance of flow between the constant volume production of chilled water and its variable volume distribution is handled with a bypass pipe commonly called a "decoupler." The decoupler bypasses surplus chilled water when production exceeds distribution and borrows return water when distribution exceeds supply. This concept ensures energy efficiency as the variable pumping operates at low rpm/energy in response to the lower loads during lean periods. This concept is usually found in large campus like facilities having large distribution piping. In this scheme, the constant chilled water pumps are selected for low head to account for the pressure drop in a decouple ring main rather than elevating head to the remotes air handling unit.

Figure-3: The scheme is shown for simplicity of understanding, which represents the chilled water system with storage tank in between. In effect, this is the modified

arrangement of the figure-2 if one can imagine a “decoupler” pipe itself can serve as a chilled water storage tank if its volume is large enough. During on-peak time the valve V-1 shall be closed and the chilled water demand shall be met through the chilled water stored in the storage tank. The chillers shall resume duty during nighttime to take advantage of off-peak operation.

CHILLED WATER TANK ARRANGEMENT SCHEMES

Most common chilled water arrangement schemes uses either the

- 1) Stratified Storage Tanks arrangement
- 2) Parallel Storage Tanks arrangement

Stratified Storage Tanks

Chilled water is generally stored at 39°F to 42°F, temperatures directly compatible with most conventional water chillers and distribution systems. Return temperatures of 58° to 60°F or higher are desirable to maximize the tank temperature difference and minimize tank volume.

Tank volume is affected by the separation maintained between the stored coldwater and the warm return water. Most chilled water storage systems installed today are based on designs that exploit the tendency of warm and cold water to stratify. That is, cold water can be added to or drawn from the bottom of the tank, while warm water is returned to or drawn from the top. A boundary layer or **thermocline**, 9 to 15 inches in height, is established between these zones. The thermocline is the region where the CHW changes temperature between the CHW supply and the CHW return and represents lost capacity in the TES tank. Temperatures sensors located vertically every 2 ft or so measure and provide the TES tank’s temperature profile.

The **figure of merit** (FOM) is a measure of a tank’s ability to maintain such separation; it indicates the effective percentage of the total volume that will be available to provide usable cooling. Well-designed stratified tanks typically have FOMs of 85 to 95 percent.

Natural stratification has emerged as the preferred approach, because of its low cost and superior performance. Colder water remains at the bottom and warmer (lighter) water remains at the top. Specially designed diffusers transfer water into and out of a storage tank at a low velocity to minimize mixing and to assure laminar flow within

the tank. This laminar flow is necessary to promote stratification since the respective densities of the 60°F return water and 40 to 42°F supply water are almost identical.

The diffusers are a critical component of Stratified Storage tank design and, if properly designed, allow the CHW to be supplied or withdrawn in a laminar (i.e., non-turbulent) manner to prevent mixing in the TES tank between the CHW supply and CHW return.

Parallel Storage Tanks

The problems of mixing and stratification can be minimized with a multiple-tank design. This arrangement replaces the bypass pipe or decoupler with a number of separate tanks piped in parallel between the 58°F return water from the cooling coils and the 40 to 42°F supply water from the chiller(s). Each of these tanks has individually controlled drain and fill valves.

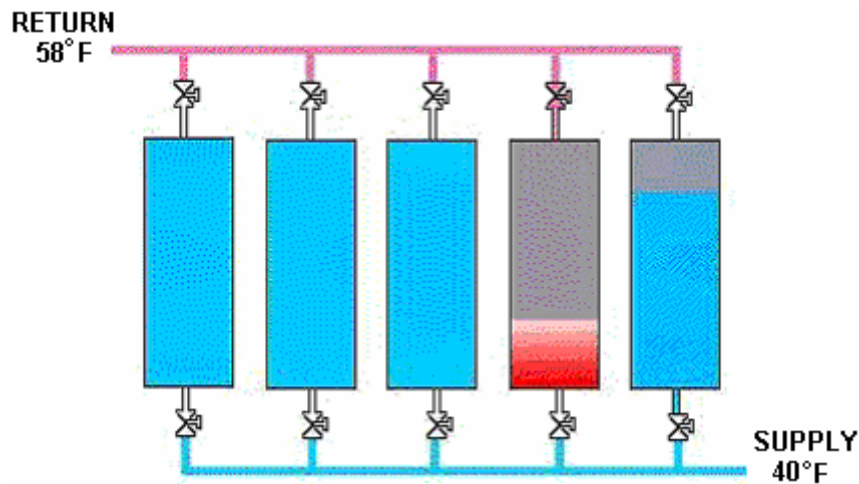

In practice, one of the parallel-piped tanks is empty, and all of the tanks' supply and fill valves are closed. When the discharge cycle starts (i.e., when the system starts to use chilled water), the empty tank's fill valve opens to allow it to receive warm return water. The supply valve on any one of the tanks filled with previously chilled water opens, too. As warm return water fills the empty tank, an equal flow of cold water is drawn from the tank with the open supply valve.

Proper valve sequencing is especially important when the receiving tank is nearly full and the draining tank is almost depleted.

Valve control sequence:

1. The supply valve on a new tank previously filled with chilled water must open.
2. The supply valve on the just-emptied tank must close as its fill valve opens, allowing the tank to receive warm return water.

3. The fill valve on the once-empty tank that is now full of warm return water must close. (This tank is now ready for off-peak recharging.)

A building automation system along with modulated supply & fill valves and an accurate method of measuring tank volume are prerequisites for this complicated control task. Although the multiple-parallel-tank scheme eliminates many of the problems associated with mixing and tank stratification, its complexity can add to the cost of a chilled water storage system.

CONTROLLING THE THERMAL STORAGE SYSTEM

Storage capacity is usually defined in ton-hours, which is the sum of the actual tons required each hour for the design day. It can be achieved using either chilled water storage or ice storage. Chilled water storage typically requires more space ($\frac{1}{2}$ to 1 gal per sq ft of conditioned space) than ice storage (around $\frac{1}{16}$ gal).

Control strategies for TES systems are often classified into categories such as partial storage, full storage, demand limiting, load leveling, chiller priority, and ice storage priority. But the same application can often use a variety of those strategies, and they can change over time, even on a daily basis. Let's take a quick look at the two most commonly used strategies - partial storage and full storage.

Partial storage (load leveling)

In partial storage systems, only a portion of the daily load is generated during the previous off peak period and put into storage. During the peak period, the load is satisfied by a simultaneous balancing operation of the installed machinery and stored energy in order to satisfy the overall daily design duty.

Partial-storage systems use smaller chillers, cooling towers, and a TES system to provide a facility's daily total cooling load needs, with a plant running at a constant load about equal in tons to $\frac{1}{24}$ of the daily total ton-hours. During peak cooling hours the chiller continues to run, and its capacity is augmented by the ice (or chilled water) in the thermal storage tanks. During off-peak hours the chillers are kept running, to either store chilled water or to make ice. This is the most commonly used strategy since the size of both the chiller and storage tanks is minimized, and often yields the fastest payback. The fastest payback, however, is not always the lowest life-cycle cost.

A partial-storage strategy, also called load-leveling system (see figure below) is most effective where the peak-cooling load is much higher than the average load.

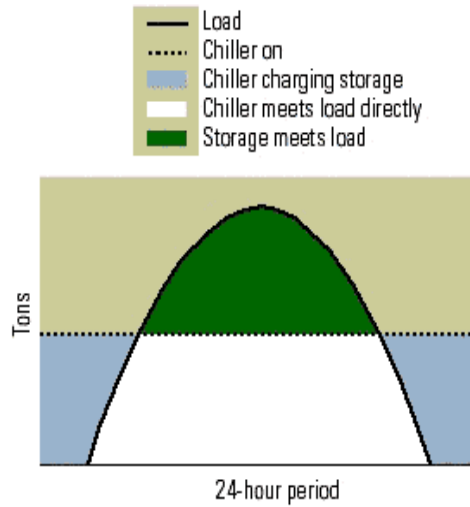

Source: ASHRAE Design Guide for Cool Thermal Storage

In a demand-limiting system, the chiller runs at reduced capacity during on-peak hours and is often controlled to limit the facility's peak demand charge (see figure below). Demand savings and equipment costs are higher than they would be for a load-leveling system, and lower than for a full-storage system. The demand limiting system could be categorized as:

Full recharge - recharging storage with chiller operation

Partial recharge - recharging storage with chiller capacity while simultaneously providing capacity to the cooling load.

Standby - no normal use of storage, with chillers serving the cooling loads as they would in the absence of storage. Storage used when power outages occur.

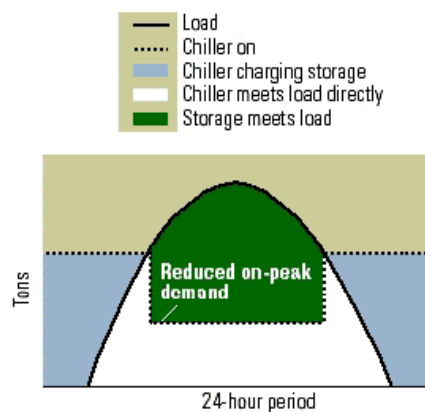

Source: ASHRAE Design Guide for Cool Thermal Storage

Full storage (load shifting)

Full storage refers to discharging stored capacity without any concurrent chiller operation.

A full-storage strategy, also called **load shifting**, shifts the entire peak cooling load to off-peak hours. The system is typically designed to operate at full capacity during all non-peak hours to charge storage on the hottest anticipated days. This strategy minimizes the electric demand charge and takes maximum advantage of the lower off-peak electric rates. However, it does so at the expense of larger chillers and ice storage equipment, because they will not be operating together as they do in the partial storage, load-leveling strategy.

This strategy is most attractive where on-peak demand charges are high or the on-peak period is short.

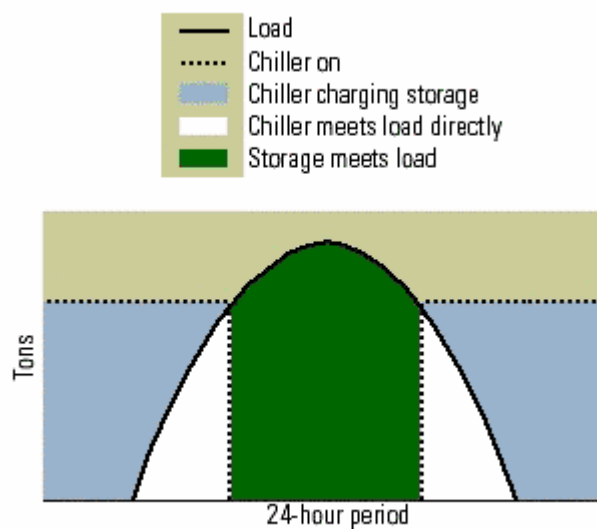

Source: ASHRAE Design Guide for Cool Thermal Storage

Full-storage systems typically require larger storage systems and larger chiller plants than partial storage systems. Full-storage systems hold the chiller plant off during the period of highest energy charges (the on-peak period) and meet the cooling load solely from thermal storage during that period. Full-storage TES systems, therefore, gain their major advantage from the difference between on-peak and off-peak electric demand charges and energy rates. Partial storage systems also benefit from these factors to a smaller degree. Since TES allows the shift of electrical demand and energy consumption to off-peak periods, users can achieve large electricity cost savings when the central plant uses electric-drive chillers.

What frequently occurs is that some combination of these two strategies is implemented. Sometimes utilities providers will establish daytime windows at peak

demand times with higher rates; in such instances, the chillers will be controlled to cycle off during these small windows. This compromise reduces equipment sizes somewhat, while taking greater advantage of energy saving opportunities. These compromise strategies can take many forms. For example, if the building has two chillers, both may run at night to make ice, but only one will be allowed to operate during the day.

It should also be noted that the terms "partial storage" and "full storage" are actually based on sizing the equipment for design load days. Under part load conditions, a system designed for partial storage may be switched to a full storage strategy if the chiller is able to make enough ice at night to satisfy the entire expected load for the next day without assistance from the chillers during the on-peak hours.

Off-peak operation

Running the chiller at night substantially reduces electrical costs since energy is used off-peak when electric generating facilities are typically under-utilized by 50 percent or more. Many suppliers offer time-of-use rates that include a 20 to 90 percent reduction in electrical energy prices at night specifically to encourage load shifting. This, with the reduction of all or part of the demand charges, results in a substantial saving in operating costs. In general, TES increases a building's load factor, which significantly reduces operating costs and increases a user's ability to negotiate favorable rates. In essence the customer becomes a Preferred Power User.

Constant full-load operation

On-off cycling and capacity modulation occurs throughout the day in most air conditioning systems in response to the cooling load of the building. Therefore, most air conditioning systems operate within their most efficient range less than 25 percent of the time. With the Ice Bank System, the chiller runs at or near full load (peak efficiency) continuously, eliminating the inefficient cycling that accompanies part-load operation.

Key Design Parameters

Key basis-of-design items for stratified chilled water (CHW) TES system are:

- Required thermal storage capacity (often measured in ton-hours);
- Chilled water (CHW) system ΔT ;

- The peak day cooling load profile and the “shape” of the load curve (which establishes the required ton-hours);
- The thermal storage strategy (full or partial storage)

The design ΔT is a critical factor with stratified TES systems in obtaining the design thermal storage capacity and predicted economic results since the thermal storage capacity is directly proportional to the ΔT ($Q = m * c * \Delta T$).

CHW systems operating with relatively small ΔT , even a few degrees less than the design ΔT can have a dramatic impact. For example, on a $16^\circ\Delta T$ system, a 1° drop in ΔT to 15° represents a 6% loss of TES capacity.

The ΔT of the distribution system and/or the chiller system is not necessarily the same as that in the TES tank. The chillers must, however, produce water at least as cold as that stored in the TES tank. The CHW return temperature from the building(s) coils determines how high the CHW return temperature will be.

The peak day cooling load profile not only shows the facility’s peak cooling load, and the shape and nature of the load, but also provides the day’s required ton-hours as represented by the area under the cooling load profile curve. Along with the CHW ΔT , the peak day’s cooling load in ton-hours and the TES strategy to be employed were key information used by the designer to size the TES tank.

Successful CHW TES Design Strategies (Basis of Design)

Experience indicates that successful CHW TES strategies employ “High ΔT CHW systems”. As noted above, it is extremely important to maintain a constant and a high ΔT for a successfully stratified CHW TES. This cannot be overstated; it is key to the economic success of TES. A CHW system operated or designed for 10° vs. $20^\circ\Delta T$ requires twice the TES tank capacity and flow rate to achieve the same cooling load. In addition, the TES tank costs are substantially higher.

Also, pumping energy is roughly proportional to the cube of the flow. Thus, all else being equal, twice the flow rate requires nearly eight times the pumping horsepower and energy. Of course, to help achieve high ΔT s, it is critical to use variable flow with two-way valves to control cooling loads.

As a typical CHW TES tank is an “open” tank (i.e., vented to the atmosphere), it is preferred if the TES tank can be located so that the TES tank water level is higher than any other point in the CHW system. Otherwise pressure-sustaining valves or other pressure control/separation methods are required.

Whenever possible, design and construct simple systems that do not require complicated controls or sequences of operations to operate properly. Installing a single TES tank so that the water level is above the highest coil will simplify the system.

ASHRAE STANDARD 150

The purpose of ASHRAE Standard 150, “Method of Testing the Performance of Cool Storage Systems,” is to “prescribe a uniform set of testing procedures for determining the cooling capacities and efficiencies of cool storage systems.” The Standard 150 test is the functional performance test at the end of the project that evaluates if the project as a whole achieved the design intent. Standard 150 in brief covers the requirements for:

- Testing;
- Instrumentation;
- Test methods and procedures;
- Data and calculations; and
- The test report.

Important aspects of ASHRAE Standard 150 are that it requires and details initialization requirements (e.g., the TES system shall be operated through at least five cycles before testing), the testing apparatus required (e.g., flow and temperature elements), and points to be measured. Standard 150 also provides instrumentation calibration procedures, and accuracy, precision, and resolution requirements to minimize test uncertainty. For example, temperature difference sensors must have accuracy of at least plus or minus 0.2°, and flow meters must be installed with 20 pipe diameters upstream and 10 diameters downstream in order to achieve an uncertainty of plus or minus 10%.

To meet ASHRAE Standard 150 requirements, the following are completed:

- Discharge test;
- Charge test;
- Cool storage capacity test; and
- The cool storage system efficiency test.

The charge and discharge tests may be performed simultaneously. One issue that often arises is that rarely will the facility be experiencing the peak cooling load at the

time that functional performance tests are conducted. For example, the TES system may be constructed during the winter period so as to be ready for the summer cooling season. ASHRAE Standard 150 provides some methods of accounting for this common occurrence including operating existing or temporary heat in conditioned spaces to provide a “false” cooling load.

PART – III ICE THERMAL STORAGE SYSTEMS

Ice thermal storage is the process of generating and storing ice at night to cool a building the next day. With an advantage of using off-peak tariffs, smaller chillers and the potential for the low first cost, ice thermal storage offers an energy-saving technology to accommodate new changes and trends in the electric power industry.

For ice storage technology, special ice-making equipment is used or standard chillers are selected for low temperature duty. Ice storage systems use a standard centrifugal, screw or scroll chiller to make ice.

The heat transfer fluid may be the refrigerant itself or a secondary coolant such as glycol with water or some other antifreeze solution. Storage volume is generally in the range of 2.4 to 3.3 cubic feet per ton hour, depending on the specific ice storage technology.

The ice supplements or even replaces mechanical cooling during the day when utility rates are at their highest and can result in significant operating cost savings.

How Ice-storage Works

In a conventional chiller air-conditioning system, the "chiller plant" must be sized to meet the maximum air-conditioning load of the building. In contrast, only a small refrigeration plant (40 to 60%) is needed in an ice storage TES. The chillers work continuously to produce ice during night, and the ice is melted the next day when the air-conditioning is required.

The most prevalent ice storage technologies are:

- 1) Ice maker systems (ice harvester including spray-slush ice)
- 2) Ice-on-coil in an open water side system (requires some periodic water treatment)
- 3) Ice-on-coil using brine in a closed (pressurized) water side system, and
- 4) Other system types (such as encapsulated ice, ice balls, eutectic salt storage) are variations being developed and commercialized.

Large capacity static type (ice-on-coil) and dynamic type (ice harvester, super cooled water) ice storage systems have been developed with the aim of compactness and high performance. These systems integrate seamlessly into overall energy management strategies and can be precisely controlled using building automation systems.

Ice Maker Systems

These are typically either a dynamic ice harvester or a spray slush-ice system.

To produce ice, 32°F water is drawn from the storage tank and delivered to the ice harvester by a re-circulation pump at a flow rate of 8 to 12 GPM per ton of ice-producing capacity. As the water flows on the refrigerated plate surfaces of ice harvester, it freezes to a thickness of 1/8 to 3/8 inch because of integral refrigeration system of the ice harvester that maintains the plates at a temperature of 15 to 20°F. On reaching a given thickness - or at the initiation of a time clock - the ice is periodically ejected into the storage tank that is partially filled with water.

When cooling is required, the icy cold water is pumped from the tank via transfer pumps to a building heat exchanger.

Return water is pumped back over the ice harvester or directly into the tank.

The ice harvester is a packaged piece of equipment; that not only simplifies installation and controls installed cost, but also suggests the availability of factory-tested performance.

Ice harvesters are not without limitations - particularly since harvester is installed above an open tank that stores a combination of water and flakes of ice. Water treatment is necessary because of the open nature of the tank and drain pan. The plates and chassis of the ice harvester are normally constructed of stainless steel. The complexities of evenly distributing the ice in the bin and prevention of piling and bridging add to the cost and operation of this system. Finally, the ice harvester's inability to produce chilled water without depleting the ice in the storage tank may be an economic deterrent.

ICE HARVESTER SYSTEM

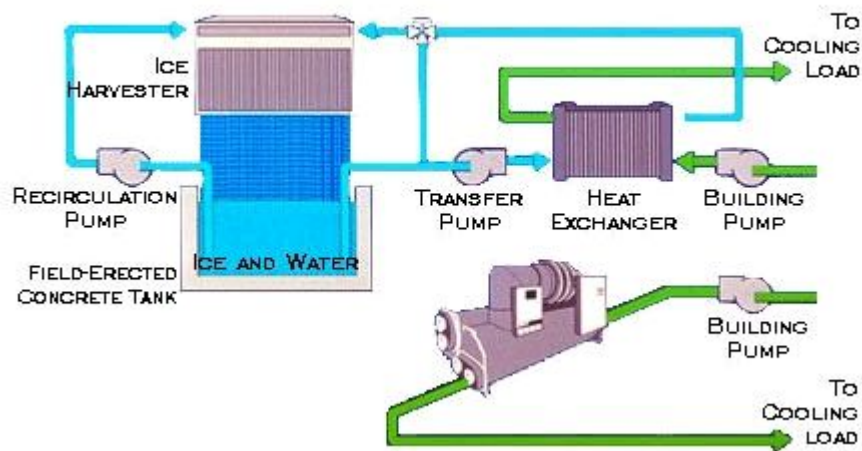

It is possible to use the ice harvester as a water chiller by raising the suction temperature of the refrigeration system and pumping warm water from the building heat exchanger over the refrigerated plates. But due to efficiency reasons, ice harvesters are commonly used in tandem with conventional water chillers.

A cost line analysis of ice harvester systems indicates the increasing costs of both the tank and the harvester as the quantity of ice stored increases. Given their high dollar-per-ton cost, ice harvester systems are usually used to provide additional capacity in retrofit applications, or in large installations.

The other icemaker type is 'Spray slush-ice systems' that is similar except it use a water/glycol solution to generate an icy slush.

External melt ice-on-coil systems

This system uses submerged pipes through which a refrigerant or secondary coolant is circulated. Ice accumulates on the outside of the pipes. Storage is discharged by circulating the warm return water over the pipes, melting the ice from the outside. External melt and ice-harvesting systems are more common in industrial applications, although they can also be applied in commercial buildings and district cooling systems.

Internal melt ice-on-coil systems

This system also feature submerged pipes on which ice is formed. Storage is discharged by circulating warm coolant through the pipes, melting the ice from the inside. The cold coolant is then pumped through the building cooling system or used

to cool a secondary coolant that goes through the building's cooling system. Internal melt ice-on-coil systems are the most commonly used type of ice storage technology in commercial applications.

Other system types (such as encapsulated ice, ice balls etc)

These use water inside submerged plastic containers that freeze and thaw as cold or warm coolant is circulated through the storage tank holding the containers.

Encapsulated ice systems are suitable for many commercial applications particularly for enhancing the capacity of existing chilled water system.

SYSTEM ARRANGEMENTS

1) Open System

Cold refrigerant or a brine solution is circulated through pipe coils submerged in an open water tank as shown below. During the charge cycle, ice forms on the pipe coils until a satisfactory thickness (typically 2" to 3") is achieved. During normal operation, chilled water is circulated to the load, and the ice remains in storage. During the discharge cycle, the chilled water flows through the storage tank(s) and is chilled by the melting ice. This is also referred as an open system.

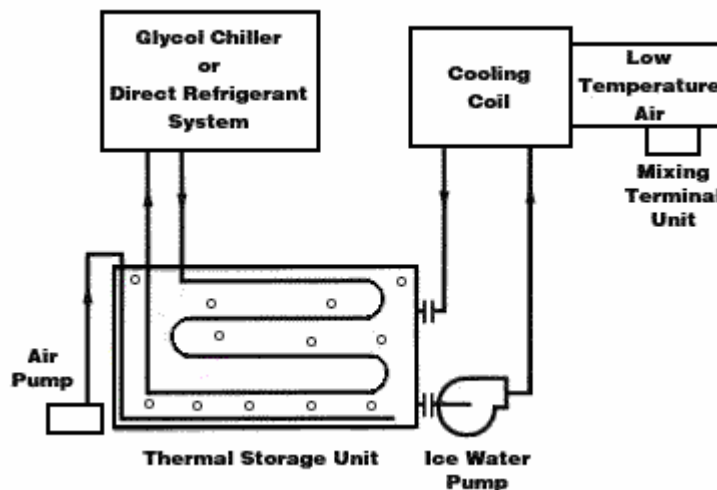

2) Closed System

Where a closed circulating system is required, a heat exchanger is used between the circulating ice water and building chilled water as shown in the following:

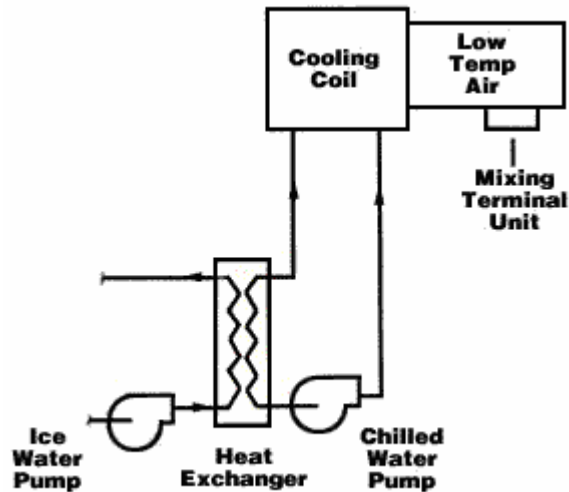

3) Modular Ice Storage Systems Using Brine

Another popular variation is the modular ice storage system using glycol brine. Ice storage systems typically feature a battery of ice tanks. Chilled brine is circulated through a series of heat exchange tubes to freeze most of the liquid in the tank to ice.

In the charge cycle, an automatic diverting valve bypasses the cooling coils and the refrigerated brine builds ice. This system is essentially a closed system.

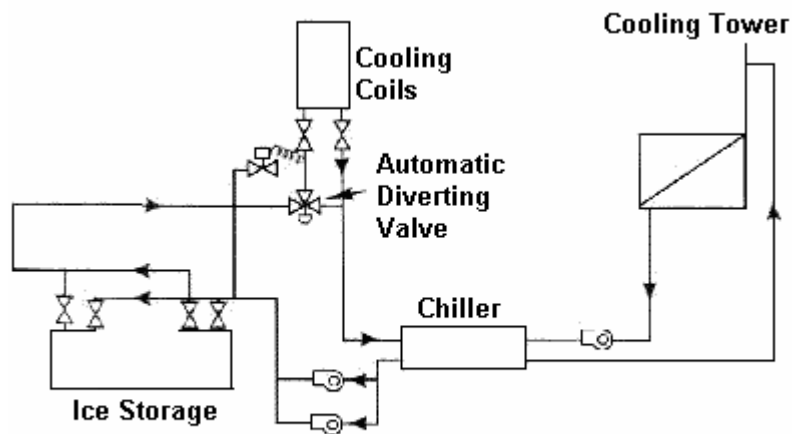

MODULAR ICE STORAGE SYSTEM USING BRINE

At night, water containing 25% ethylene glycol is cooled by a chiller and is circulated through the tank's heat exchanger, bypassing the air handler coil. The cooled water-glycol solution extracts heat until eventually about 95% of the water in the tank is frozen solid. The water-glycol solution is nearly dropped to 25°F that freezes the water surrounding the heat exchanger. The ice is built uniformly throughout the tank by the patented temperature-averaging effect of closely spaced counter-flow heat

exchanger tubes. Water does not become surrounded by ice during the freezing process and can move freely as ice forms, preventing damage to the tank.

It should be noted that, while making ice at night, the chiller must cool the water-glycol solution to 25° F, rather than produce 44 or 45°F water temperatures required for conventional air conditioning systems. This has the effect of "de-rating" the nominal chiller capacity by approximately 30 to 35 percent. Compressor efficiency, however, will vary only slightly (either better or worse) because lower nighttime temperatures result in cooler condenser temperatures and help keep the unit operating efficiently.

The following day, the stored ice cools the solution from 52° F to 34° F. A temperature-modulating valve set at 44° F in a bypass loop around the tank permits a sufficient quantity of 52° F fluid to bypass the tank, mix with 34 F fluid, and achieve the desired 44 F temperature. The 44° F fluid enters the coil, where it cools air typically from 75° F to 55° F. The fluid leaves the coil at 60 F, enters the chiller and is cooled to 52 F.

The glycol recommended for the solution is an ethylene glycol-based industrial coolant, which is specially formulated for low viscosity and superior heat transfer properties. These contain a multi-component corrosion inhibitor system, which permits the use of standard system pumps, seals and air handler coils. Because of the slight difference in heat transfer coefficient between water-glycol and plain water, the supply liquid temperature may have to be lowered by one or two degrees.

Benefits of Ice Storage System

The ice systems use smaller components than traditional cooling systems, resulting in significant operating cost savings and lower first costs. Ice storage has the potential to reduce both system demand and overall energy costs. In addition to the incentives provided by the electrical companies on the use of off-peak tariff for ice making, the benefits of ice storage system are summarized below:

Reduced Capital Outlays

1) Equipment Sizes Reduced

An ice storage system can reduce chilled water flow requirements by half. This result in attractive first cost and operating cost benefits. For a building demanding 400 tons of air-conditioning, the advantages are exemplified by the installations below.

A traditional chilled water system using 44°F (6.7°C) supply and 54°F (12.2°C) return will require 2.4 gallons per minute (GPM) of chilled water for each ton-hour of refrigeration. An ice storage system can supply chilled water at 34°F (1.7°C), reducing the required chilled water flow to 1.2 GPM. That shall require smaller pipe sizes and chilled water distribution pumps.

2) Savings on chilled water piping:

Pump and pipe sizes are reduced in an ice storage system. Users realize substantial savings with the chilled-water distribution loop when the system design incorporates reduced flow rates. Use of a 14°F temperature range instead of a conventional 10°F temperature range results in a reduction of pipe size from 8" to 6". This reduction in pipe size corresponds to a \$60,000 cost savings for the pipe for a typical 400-TR chilled water distribution piping.

3) Savings on condenser cooling water piping:

Condenser water pipe sizes decrease due to lower flow requirements for the smaller chiller. Using 3 GPM/ton, the condenser water piping drops from 8 in. on a conventional system to 6 in. for the ice storage system. This results in cost savings of \$8,000. Pump savings due to reduced chilled water and condenser water flow rates also decrease, and in this example, calculate to \$3,000.

4) Saving on chiller sizes:

By designing a system around 24-hr/day chiller operation, the size of the chillers and cooling towers required for an ice system is significantly reduced compared to conventional chillers and cooling towers sized for the instantaneous peak load. For example, a partial-storage ice design includes chillers that provide approximately 50% to 60% of the peak-cooling load. The ice storage system handles the balance of the cooling requirement. In a 400-ton peak cooling load system, ice storage reduces the nominal capacity of the chiller and cooling tower from 400 tons to 200 tons with associated savings of \$73,500 by allowing users to take advantage of the low temperatures available with ice.

5) Savings on electrical connected load:

As the size of major components of the mechanical system drop, the HP associated with these components falls, too. Continuing the above example, total connected hp falls by 190 hp, resulting in savings for transformers, starters, and wiring of approximately \$28,000 with total system savings of \$172,500.

6) Additional cost of TES:

Ice thermal storage requires some additional components such as the ice thermal storage units, ethylene glycol, heat exchanger, and concrete slab, which total \$137,600.

In summary, the first cost savings due to smaller chillers and cooling towers, reduced pump and pipe sizes, and less connected hp shall offset the additional cost TES items such as storage tank/s, heat exchanger and civil works.

For the 400-ton example, the ice thermal storage system nets nearly a \$35,000 first-cost savings or almost \$90/ton. Off-course the savings shall be higher for the bigger system.

Operating Costs Reduced

The ice systems use smaller components than traditional cooling systems, resulting in even more operating cost savings and lower first costs.

1) Savings on indirect electric bills:

Operating costs decrease when the system is designed to take advantage of low nighttime electrical rates and have the flexibility to adjust to changes in peak electrical rates with deregulation.

Demand charges can make daytime energy costs as much as six times greater than nighttime energy costs. With the switch over to deregulation, on-peak daytime energy rates are expected to increase significantly while nighttime rates are expected to remain flat or decrease.

With a 400-ton system, end users realize annual operating cost savings of \$13,240 based on a \$10/kW demand charge and usage charges of \$0.06/kWh peak and \$0.03/kWh off peak. Ice thermal storage systems pass along optimum operating cost savings with a proper system design and strategy.

2) Savings on direct electrical bills:

Ongoing operating costs also decrease with an ice storage system, which reduces supply water temperature to 36°F. For example, with lower hp of smaller pumps, fans, cooling tower and chiller result in as much as a 25% increase in operating energy savings over a traditional chiller system.

The air-handling unit fans accounts for significant operating energy to the tune of 30 to 50%. The low chilled water distribution to air-handling unit cooling coils provides lower temperature air for space cooling. When low temperature air distribution 42°F

(6°C) supply air versus traditional 55°F (17°C) air supply is also used, the airflow volume gets reduced and the additional savings are realized from the lower airflow or lower capacity fans.

Reliability & Redundancy

Another advantage of ice storage is standby cooling capacity. If the chiller is unable to operate for any reason, one or two days of ice may still be available to provide standby cooling.

With conventional systems, installing multiple chillers offers redundancy. In the event of a mechanical failure of one chiller, the second chiller supplies limited cooling capacity. The maximum available cooling for the conventional system would, with one chiller out of service, be only 50% on a design day.

Most ice storage systems utilize two chillers in addition to the ice storage equipment. Two chillers provide approximately 60% of the required cooling on a design day while the ice storage provides the remaining 40% of the cooling capacity. In the event that only one chiller is available to provide cooling during the day, up to 70% of the cooling capacity is available. The one operable chiller supplies 30% of the cooling requirement, while the ice provides up to 40%. Based on typical HVAC load profiles and ASHRAE weather data, 70% of the cooling capacity would meet the total daily cooling requirements 85% of the time.

Higher system reliability also translates to lower maintenance. In an ice thermal storage system, all equipments are smaller than those in conventional systems, which reduce maintenance, parts, and labor. Ice coils themselves have no moving parts and essentially require no maintenance. An ice inventory sensor requires adjustment twice annually. Water in the tank and glycol in the ice coils only need an annual analysis. With minimal maintenance, keeping the system operating in an environmentally friendly manner is easier, too.

OTHER BENEFITS

Cold air distribution

The ice storage systems also provide savings on the air distribution side. The use of 44°F air in the duct system rather than the usual 55°F air permits further huge savings in initial and operating costs. This colder air is achieved by piping low temperature (36-38 F) water-glycol solution from the Ice Bank tanks to the air handler coil. The 44°F air is used as primary air and is distributed to a high induction rate diffuser or a fan-powered mixing box where it is fully mixed with room air to obtain the

desired room temperature. The 44°F primary air requires much lower airflow than 55°F air. Consequently the size and cost of the air handlers, motors, ducts and pumps may be cut 20 to 40 percent. Colder air also lowers relative humidity, therefore occupants feel comfortable at higher, energy-saving thermostat settings. The building compactness and increased useable space is another benefit. The Electric Power Research Institute reports "overall HVAC operating costs can be lowered by required 20 to 60 percent by using ice storage and cold air distribution." (EPRI brochure CU-2038 "Cold Air Distribution with Ice Storage," July 1991.)

Fast installation and low maintenance

Ice Bank tanks are compact, factory made modular units, easily shipped and installed. They contain no moving parts, have no corrodible materials and are backed by a 10-year limited warranty. The tanks can be located indoors or outdoors, even stacked or buried to save space. They can also be easily moved if required in future building expansions.

Benefits electric suppliers and the environment

The Ice Bank system is a technology that conserves energy for the generators of electricity as well as the customer. Generation plants operating on peak have much higher heat rates (fuel BTUs required per kW-h generated) than energy generated at night. Fewer BTUs per kWh also means reduced air emissions, a feature that can contribute significantly to our environmental quality.

OPERATING STRATEGIES (Ice Storage)

Ice Storage can generally be classified as "Full Ice-storage" and "Partial Ice-storage" systems, depending on the amount of air-conditioning load transferred from the on peak to the off-peak period.

Full ice storage refers to an ice storage system that only runs its refrigeration compressor during off-peak periods and never uses its chillers during on-peak periods. Full ice storage system makes sufficient ice during off-peak periods and all cooling is supplied from the stored ice. By shifting all cooling load to off-peak periods, a full ice storage system is able to take advantage of the very best off-peak electric rates. This strategy, which is demand- or usage-charge driven, shifts the largest amount of electrical demand and results in low operating costs. However, due to larger storage requirements, full storage systems have a higher upfront cost.

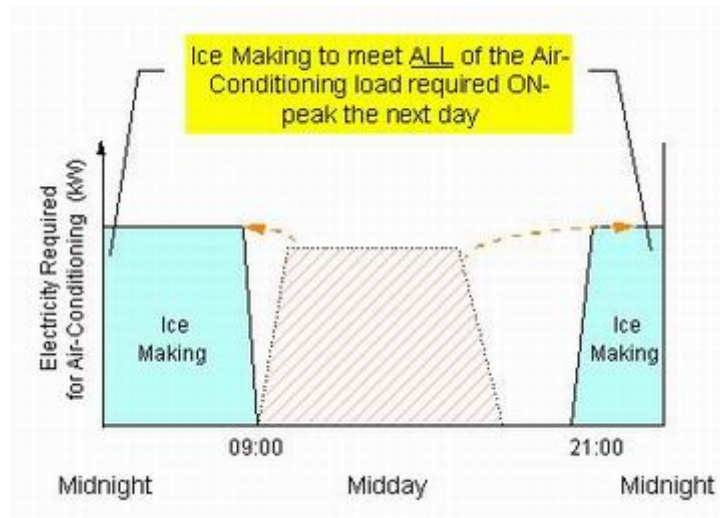

Partial ice storage on the other hand, offers the lowest first cost design as well as low operating cost. This system builds enough ice during the night to serve part of the on-peak cooling requirements. The refrigeration compressors or part off continue to operate while the stored ice supplements the peaks.

The ice is built and stored in modular ice tanks to help meet the building's cooling requirement the following day allowing chillers to be downsized or turned off.

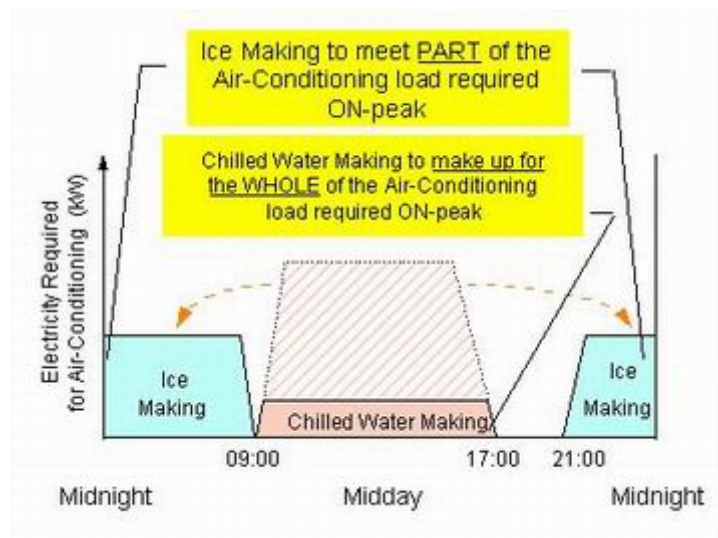

Since the stored ice acts as a supplement, the "partial ice-storage" system benefits from the reduced size and cost of the ice storage tanks and the refrigeration compressors. The refrigeration compressors need not be sized for peak load of the facility. The smaller size of refrigeration compressors implies reduced electrical connected load and thus reduced maximum demand that otherwise would have occurred. The optimum amount of storage is achieved by maintaining a minimal equipment cost while maximizing electricity savings.

The partial ice storage is best suited where the expansion of existing chilled water system facility is desired.

Full Storage or Partial Storage!

The electric rates will determine which control strategies are best for the project. When electric rates justify a complete shifting of air-conditioning loads, a conventionally sized chiller can be used with enough energy storage to shift the entire load into off-peak hours. Since the chiller does not run at all during the day, it results in significantly reduced demand charges. A full storage TES system provides enough cooling capacity to meet a building's cooling requirements during on-peak periods.

In new construction, a partial Storage system is usually the most practical and cost-effective load management strategy. In this case, a much smaller chiller is allowed to run any hour of the day. It charges the ice storage tanks at night and cools the load during the day with help from stored cooling. Demand charges are greatly reduced and chiller capacity often decreases by 50 to 60 percent or more.

A partial storage system is generally used in conjunction with a conventional cooling system.

PART – IV

SELECTING A RIGHT SYSTEM

Several factors influence the selection of the type of system that will best meet your building's needs. These include building occupancy type, operating characteristics, and 24-hour building load profile for the design day, the amount of available space for storage, and compatibility with planned heating, ventilating, and air conditioning equipment.

When evaluating a TES system, take into consideration the following features:

- Sizing basis (full storage, load leveling, or demand limiting)
- Sizing calculations showing chiller capacity and storage capacity, and considering required supply temperature
- Design operating profile showing load, chiller output, and amount added to or taken from storage for each hour of the design day
- Chiller operating conditions while charging storage, and if applicable, when meeting the load directly
- Chiller efficiency under each operating condition; and
- Description of the system control strategy, for design-day and part-load operation
- Ease of control: The easier a system is to operate, the better it will perform. Simple controls help minimize operator problems that may lead to system downtime.

Description of the proposed storage system, including:

- Operating cost analysis
- Demand savings
- Changes in energy consumption and cost
- Description and justification of assumptions used for annual demand and energy estimates
- Cost analysis

The most favorable applications are in buildings having high cooling needs for relatively short time periods (such as churches and sports arenas), additions to a building without having to add cooling capacity, and in areas where electric peak demand charges are very high and applicable over a relatively short time period

(called the "on-peak" period). Thermal storage systems should be designed to accommodate the desired operating mode.

For cool storage, full storage usually makes more sense than partial storage and ice storage more sense than chilled water storage (when equally well designed).

Perform a detailed feasibility study that must include the life cycle analysis by an established procedure. To perform the study, the information and guidelines can be referred from the Design Guide for Cool Thermal Storage, published by the American Society of Heating, Refrigerating and Air-Conditioning Engineers Inc. (order at www.ashrae.org).

Pros & Cons of Chilled water/ Ice storage systems

TES technologies for cool storage include two distinct types:

- Latent heat storage systems, such as ice TES, in which thermal energy is stored as a change of phase of the storage medium, usually between solid and liquid states;
- Sensible heat storage systems, such as chilled water and low temperature fluid TES, in which thermal energy is stored as a temperature change in the storage medium

Each TES technology has inherent advantages and limitations, and no single type is appropriate for all applications. Generalizations can be made and used as approximate rules of thumb, such as those presented in Table below. Of course, any generalizations should be viewed with some caution, as a fuller understanding of the technologies is important to optimally select and employ TES for specific applications.

Storage medium	Volume (feet³/ton-hour)	Storage temperature (degrees F)	Discharge temperature (degrees F)	Strengths
Chilled water	10.7-21	39-44	41-46	Can use existing chillers; water in storage tank can do double duty for fire protection
Ice	2.4-3.3	32	34-36	High discharge rates; potential for low temperature

Storage medium	Volume (feet³/ton-hour)	Storage temperature (degrees F)	Discharge temperature (degrees F)	Strengths
				air system The ice bank storage use roughly 0.70% of the floor space for full storage.
Eutectic salts	6	47	48-50	Can use existing chillers

The difference between ice storage systems vs. chilled-water storage system is that ice can “store” more thermal energy per pound than “liquid” water.

Chilled water storage systems use the sensible heat capacity of water-1 Btu per pound per degree Fahrenheit (F)-to store cooling capacity. Given, a water specific heat of 1 Btu/lb F, about 10 cu ft of water are required to absorb 12,000 Btu's and provide 1 ton-hour of cooling if the coil successfully raises the water temperature by 20°F. By contrast, the same ton-hour of cooling can be provided with just 1.5 cu ft of ice, since each pound of ice absorbs 144 Btu's as it melts. Ice thermal storage systems use the latent heat of fusion of water--144 Btu/lb, to store cooling capacity. Therefore, a thermal storage system that uses chilled water rather than ice will require 6 to 7 times more installed storage volume.

Chilled water systems require the largest tanks, but they can easily interface with existing chiller systems. Ice systems use smaller tanks and offer the potential for the use of low-temperature air systems, but they require more complex chiller systems. Eutectic salts can use existing chillers but usually operate at the warmest temperatures.

Keep in mind, however, that the cost of the water storage tank is a function of its surface area, while the capacity of the tank is a function of its volume. Therefore, as a system requires very large chilled water storage tanks, the per-ton-hour cost of the storage tank actually decreases. Consequently, it appears that chilled water may be competitive with ice in applications that require more than 10,000 ton-hours of thermal storage. Because of the decreasing unit cost of the tanks, chilled water

storage can be economically attractive in larger systems. These systems also allow the chiller to operate at peak efficiency during the storage cycle.

Chilled water thermal storage systems offer a number of **attractive benefits**. Note as well, that storing a large volume of water on site can be a valuable asset for fire/life safety systems. In fact, some system designs use sprinkler system water in their design. They operate at temperature ranges compatible with standard chiller systems and are most economical for systems greater than 2,000 ton-hours in capacity.

The **disadvantages** of chilled water storage - most of which relate to the tank - must also be recognized. The storage tank's design, weight, location and space requirements can pose some unusual problems...along with tank leakage. In addition, storage tank costs can vary significantly because the tank is constructed on site. And, don't forget water treatment cost. The water stored is used in the chilled water system as well.

Perhaps the most significant problem with chilled water as a storage medium is inherent to the chilled water system itself. To be effective, chilled water storage systems must raise the return water temperature to relatively high values. If the chilled water distribution system cannot achieve this, the Btu storage capacity of the tank is severely impaired. Continual monitoring and disciplined maintenance of the chilled water valves and controllers are required to assure that chilled water always returns to the tank at the warmest possible temperature.

The main advantage of ice storage is that it requires less space, can provide colder air to the building, and reduces duct and fan size and introduction of less humid air into occupied spaces. Any application over 100 tons provides an opportunity for savings via ice thermal storage. For many retrofits, ice thermal storage allows the end user to decrease chilled water temperature in the loop, adding as much as 50% more cooling capacity to piping. The system can also lower water temperature and drop the leaving air temperature, which increases capacity utilizing the same duct and fan systems. Overall, designers can unlock some pretty "cool" ideas from the ice storage vault.

The disadvantage with ice storage systems is it consumes more energy. This has often been true where demand reduction was the primary design objective. Ice storage system does require the chiller to work harder to cool the system down to the required lower temperatures; and energy is needed to pump fluids in and out of storage. The refrigeration equipment capacity is de-rated by 25 to 30%. But since the storage systems let chillers operate at full load at night, versus operating at full or

part load during the day, the chiller may be smaller than would be required for direct cooling, allowing smaller auxiliaries such as cooling tower or condensing system. The system if carefully designed with right operating strategy shall more than balance the increased consumption. Special ice-making equipment or standard chillers modified for low-temperature service are often used.

Where TES is effective?

Cool storage will reduce the average cost of energy consumed and can potentially reduce the energy consumption and initial capital cost of a cooling system compared to a conventional cooling system without cool storage. While most building space cooling applications are potentially attractive candidates, the prospects will be especially attractive if one or more of the following conditions exists.

- Electricity energy charges vary significantly during the course of a day.
- Electricity demand charges are high or ratcheted.
- The average cooling load is significantly less than the peak cooling load.
- The electric utility offers other incentives (besides the rate structure) for installing cool storage.
- An existing cooling system is expanded.
- There is new construction.
- Older cooling equipment needs replacing.
- Cold air distribution benefits can be captured.

What to Avoid

In general, applications lacking the conditions identified above should be avoided. In addition, if one or more of the following is true, TES may not be an appropriate technology:

- The maximum cooling load of the facility is very close to the average load. A TES system would offer little opportunity to downsize chilling equipment. For instance in the electrical substation or manufacturing facility where the majority of total heat load is due to sensible heat of equipment, there is hardly any variation in total heat load when the facility is running.

- On-peak demand charges are low and there is little or no difference between the costs of on- and off-peak energy. There is little economic value for customers to shift cooling to off-peak periods.
- The space available for storage is limited, there is no space available, the cost of making the space available is high, or the value of the space for some other use is high.
- The cooling load is too small to justify the expense of a storage system. Typically, a peak load of 100 tons or more has been necessary for cool storage to be feasible.
- The design team lacks experience or funding to conduct a thorough design process. Cool storage systems are inherently more complicated than non-storage systems and extra time will be required to determine the optimum system for a given application.

Selection based on Load Profile

In conventional air conditioning system design, cooling loads are measured in terms of "Tons of Refrigeration" (or kW's) required, or more simply "Tons".

For chilled water or ice storage systems, designers select chillers based on the "Ton-hours" of cooling required.

A theoretical cooling load of 100 tons maintained for 10 hours corresponds to 1000 ton-hour cooling load.

One of the design challenges of thermal storage is to develop an accurate cooling load profile of the project. A load profile is an hour-by-hour representation of cooling loads for a 24-hr period over length of summer months. Thermal storage systems provide flexibility for varying strategies as long as the total ton-hours selected are not exceeded. This is why designers must provide an accurate load profile for an ice storage system.

Say if full 100-ton chiller capacity is needed only for two hours in the cooling cycle, for the other eight hours, less than the total chiller capacity is required. For a conventional HVAC system, a 100-ton chiller must be specified to account for the peak demand, however, with the TES design depending upon the operating strategies a 50-ton chiller with 50% storage option shall provide the same results and

meet the peak load requirements. This is called 50% diversity, which may be defined as the ratio of the actual cooling load to the total potential chiller capacity.

Dividing the total ton-hours of the building by the number of hours the chiller is in operation gives the building's average load throughout the cooling period. If the air conditioning load could be shifted to the off-peak hours or leveled to the average load, less chiller capacity would be needed, 100 percent diversity would be achieved, and better-cost efficiency would result.

The lower the Diversity Factor, the greater the potential benefit from a TES system.

CASE STUDY – HOTEL BUILDING

Consider for instance an example of a hotel. Hotel because of its varying facilities such as public spaces, room occupancy, conference rooms, banquet halls, restaurants etc has huge variation in cooling load profile. These, in fact, represent unique zones of occupancy patterns, which offer huge diversity to the peak loads.

As part of the effort to minimize cooling plant size, it is necessary to predict, with some accuracy, the diversity of the peak-cooling loads, rather than use a "sum of the peak loads" approach. It was analyzed that the sum of the peaks or the total load expected at a time is approximately 900 tons. Through a usage patterns analysis of each zone of occupancy, it was estimated that the average load is 600 tons.

Option# 1

A conventional chiller system providing partial redundancy on average load shall require an installation of 3 x 300-ton chillers. The system shall meet the peak demand of 900 tons and in normal operation 2 x 300-ton shall work to provide the average load of 600 tons. No standby is perceived to meet the peak load shortfall.

A conventional chiller system providing full redundancy shall require an installation of 4 x 300-ton chillers. The system shall meet the peak demand of 900 tons and provide 100% redundancy on peak load and 200% redundancy on the average load. The criticality of operations shall determine the full redundancy operation.

Option# 2

With thermal storage, chiller redundancy can be obtained. Select 2 x 300-ton chillers along with 300-ton ice storage bank as a virtual third water chiller. If the peak is only for 2 hours the ice storage bank shall have a capacity of 600 ton-hours.

During peak operation the cooling load shall be delivered through 2 x 300-ton chiller and the ice bank storage.

For average load, either the ice bank provides cooling along with 1 x 300-ton chiller or 2 x 300-ton machines can provide the cooling demand. In the event that the first chiller fails, the second chiller can maintain the building's cooling load.

By carefully calculating the cooling load pattern, the size of a thermal storage system can be minimized while maximizing the benefits of smaller chillers.

PART – V THE DISTRICT COOLING SYSTEM

District Cooling involves the generation of chilled water in a centralized system and the distribution of the chilled water, through a network of piping, to multiple cooling user facilities. District cooling utility systems involve the centralized generation and supply of chilled water by an entity, operating as a utility business, from which the chilled water is sold to multiple cooling customer facilities.

District cooling systems tend to be large and often employ various types of electric, non-electric, and hybrid chiller plants. These systems also sometimes employ on-site generation say with an gas fired chillers, or DG set or using gas/fuel fired vapor absorption machine or could be used where waste heat availability offer a potential for cogeneration.

District (or central) cooling systems, which distribute chilled water or other media to multiple buildings for air-conditioning, have been used in commercial buildings for decades. While district cooling systems are most widely used in downtown business districts and institutional settings, such as college campuses, they offer tremendous benefits to building owners and should be considered by developers planning large office complexes, township developers or mixed-use properties.

District Cooling Systems # Case Illustration

A facility in Abu-Dhabi, UAE is designed for 25000-tons (600000 ton-hour for 24 hrs duty) of cooling that serves township developments project spread over 30 acres complex. The district cooling system uses 2.5 mile-long networks of 36-inch pipes to deliver chilled water from the central cooling plant to the various end user points that comprises of residences, shopping mall, schools, mini hospital and community centers.

Water is chilled at a central plant to about 39°F and delivered to the air handling/fan coil units located locally at each building. The gas fired driven multiple chillers (10no.) are used to generate the chilled water. Air is cooled across the chilled water-cooling coil and is distributed indoors. The system circulates approximately 40,000 gallons or more of chilled water per minute at peak times to control the temperature in these buildings.

Salient Features are as follows:

1) Low capital cost:

A stratified chilled water TES system was selected (in lieu of an ice TES system) because water storage exhibits an inherently dramatic economy-of-scale. As the tank

capacity gets larger, its price per gallon (and thus its price per ton) gets much lower. For large district cooling system applications, the installed capital cost per ton for water TES is not only much less than for ice TES, but even much less than for conventional chiller plant capacity.

2) Low space requirements:

The district cooling system has saved the enormous square footage that shall have been required for conventional building cooling systems. The amount of lease able floor space is increased by eliminating the need for on-site mechanical equipment rooms, including chillers, cooling towers, pumps, and refrigerant-monitoring systems. The absence of cooling units at each building will even provide aesthetic benefits, eliminating the need for the typical (and sometimes architecturally challenging) rooftop-cooling unit.

3) Low first and operating costs:

The district cooling centralized facility has saved building owners more than \$ 21 million in equipment costs (bigger equipment costs less), civil construction costs due to reduced foundations & mechanical spaces and economy of scale operations. The higher space availability at the end user points have additional benefit due to rents.

4) Energy efficiency:

The chillers have been designed to work at full load at night and during daytime lesser number of chillers are used at peak load along with the stored chilled water capacity. The daytime ambient conditions are very harsh and the nighttime is pleasantly cool that ensures preferred condensing conditions. Chillers perform most efficiently when the outdoor temperatures are relatively low, as naturally occurs during cooler nighttime hours. Operation at night with 20-degree lower condensing temperatures can improve energy efficiency typically by 2 to 8 percent over non-storage systems operating during the day.

The large capacity chillers selected provide good efficiency and also by ensuring peak load operation of chillers all the time, considerable energy savings are achieved. Of course, with any TES system, shifting much of the chiller plant operation to low-cost, off-peak, non-demand periods also dramatically reduces operating cost.

5) Reliability and flexibility:

Stratified chilled water TES is an inherently simple system, exhibiting high reliability. The chosen combination of chillers and TES tank provide the system operators and

the users with a high level of capacity redundancy. Furthermore, TES provided the flexibility to respond effectively to uncertainties and future changing conditions in the energy marketplace.

6) Flexibility for system growth:

To provide the flexibility to more readily accommodate the future growth, the TES system is pre-designed for future conversion from stratified chilled water TES to stratified low temperature fluid TES. In this manner, the supply temperature in stratified TES can be lowered well below the normal 39°F minimum to say 34°F.

Thus with the same infrastructure, just by increasing the supply-to-return temperature difference, it shall be possible to increase the refrigeration tonnage capacity. The same distribution-piping network shall be used without changing the original pipe sizes. This is a little liberal design undertaken because the future growth was perceived with certainty.

Other wise had the TES system was designed for say 34°F from the beginning, the retrofits involving additional capacity requirements may be met by either adding more tank capacity and/or incorporating series or parallel chiller equipment into new retrofit designs that could solve problem with the existing water and air systems.

7) Low maintenance costs:

The district cooling system also reduced building maintenance costs as the centralized plant is well attended at one location plus the multiple chillers provide adequate redundancy. The selected option of stratified chilled water TES is nearly maintenance-free. The TES tank contains no moving parts. The required maintenance for the associated pumps and valves is significantly less than would have been with multiple chiller plants.

8) Environmental benefits:

Everyone benefits from environmentally friendly cooling. Individual building HVAC systems emit thermal heat that warms the local atmosphere. By using energy-efficient, centralized cooling developments have the opportunity to reduce the atmospheric warming and thus improve quality of life and preserve the environment. The noise levels have also been minimized in vicinity of public places.

Engineering & commissioning of this facility was finished much before the finish of other developmental work. Such foresight benefited not only to the developer, its partners, and tenants, but the environment, too.

It has been established that the cooling loads drives peak electric power demand. Other than TES, various technologies, including non-electric chillers, vapor absorption machines and on-site power generation play a vital role in managing these loads.

District cooling provides an opportunity to incorporate these various load management technologies, including TES, in relatively large-scale applications. The economy-of-scale inherent to chilled water TES and low temperature fluid TES, makes these attractive in large-scale applications.

TES is an attractive alternative or a supplement to additional utility peaking power plants, to on-site power generation, and to other methods of peak electric demand management. Especially in large applications such as district cooling, TES can be the optimum approach, combining proven technology with low capital cost per ton and low energy cost.

Course Summary

Thermal Energy Storage (TES) System is a technology which shifts electric load to off-peak hours, which will not only significantly lower energy and demand charges during the air conditioning season, but can also lower total energy usage (kWh) as well.

When demand for electricity is low (at night) and less expensive to purchase, conventional chillers or industrial-grade ice-making units produce and store cold water or ice. This stored coolness is then used for space conditioning during hot afternoon hours, using only circulating pumps and fan energy in the process.

Thermal energy storage (TES) systems chill storage media such as water, ice, or phase-change materials. Operating strategies are generally classified as either full storage or partial storage, referring to the amount of cooling load transferred from on peak to off-peak.

TES systems are applicable in most commercial and industrial facilities, but certain criteria must be met for economic feasibility. Capital costs of TES depend on the economy of scales. If carefully designed for new facility significant first cost operating benefits could be achieved.

A TES system can be appropriate when

- Maximum cooling load significantly higher than average load
- High demand charges, and a significant differential between on-peak and off-peak rates
- Appropriate where chiller capacity is needed for an existing system, or where back-up or redundant cooling capacity is desirable or where electrical infrastructure is inadequate to match demands

TES systems may also reduce energy consumption, depending on site-specific design, notably where chillers can be operated at full load during the night. Favorable nighttime operation and lowering the chilled water temperatures and cold air distribution can achieve significant savings achieved in pumps and fans operations. Number of other design options can make TES systems more energy efficient than non-storage systems.

Rule of Thumb Storage Tank Sizing

- Chilled water: 15 to 18 cubic feet per ton-hr
- Eutectic salt: 3.5 to 6 cubic feet per ton-hr

- Ice: 3 to 3.5 cubic feet per ton-hr

Key Facts –

Chilled water system (1 BTU/lb)

- Simple, but requires a large amount of space/ could be a problem in retrofit applications
- Typical water temperatures of 39 to 40°F
- Need to minimize mixing of warm return with the cold water in storage
- May need 2 tanks – if full capacity of a tank is needed
- If temperature stratification of tank is used, the tank may need to be up to 20% bigger

Ice Storage (144 Btu/lb)

- More complex tanks and auxiliary equipment needed
- Ice/water requires around 20 to 30% of the space needed for chilled water tanks
- Solid ice requires around 10% of the space needed for chilled water tanks
- Very low temperature water (34°F) can be used
- Options: Ice on coil, ice harvester or ice/water

Eutectic Salt Storage (50 Btu/lb)

- Expensive, high tech solution
 - Allows use of existing 44°F chillers
 - Typical melt range is 41°-47°F
 - Requires only 30 to 50% of the space needed for chilled water tanks
 - Requires secondary heat exchangers
-
-